

Time of Philosophers, Time of Physicists, Time of Mathematicians

Fabien Besnard
EPF

7 July 2010

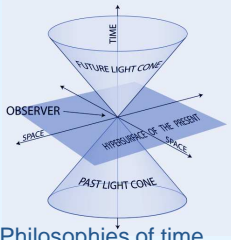

- Philosophies of time
- The Andromeda Paradox
- Consequences of the Andromeda Paradox
- Other simultaneity relations ? (1)
- Other simultaneity relations ? (2)
- Accelerated observers and PE
- Accelerated observers and OS
- Presentism and possibilism in General Relativity
- Closed time-like curves
- Quantum heads-or-tails
- The positivistic and realist postulates
- Conclusion

Table of contents

Philosophies of time

The Andromeda Paradox

Consequences of the Andromeda Paradox

Other simultaneity relations ? (1)

Other simultaneity relations ? (2)

Accelerated observers and PE

Accelerated observers and OS

Presentism and possibilism in General Relativity

Closed time-like curves

Quantum heads-or-tails

The positivistic and realist postulates

Conclusion

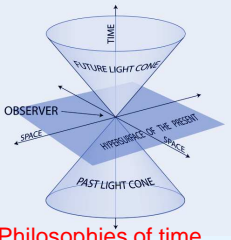

● Philosophies of time

- The Andromeda Paradox
- Consequences of the Andromeda Paradox
- Other simultaneity relations ? (1)
- Other simultaneity relations ? (2)
- Accelerated observers and PE
- Accelerated observers and OS
- Presentism and possibilism in General Relativity
- Closed time-like curves
- Quantum heads-or-tails
- The positivistic and realist postulates
- Conclusion

Philosophies of time

1. Presentism: only the present exists

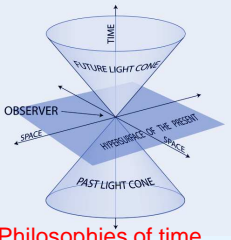

● Philosophies of time

- The Andromeda Paradox
- Consequences of the Andromeda Paradox
- Other simultaneity relations ? (1)
- Other simultaneity relations ? (2)
- Accelerated observers and PE
- Accelerated observers and OS
- Presentism and possibilism in General Relativity
- Closed time-like curves
- Quantum heads-or-tails
- The positivistic and realist postulates
- Conclusion

Philosophies of time

1. Presentism: only the present exists

- (a) Time passes,
- (b) The future is open,
- (c) One may travel in space, not in time,
- (d) Ontological parsimony.

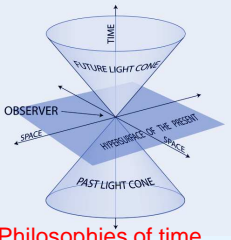

● Philosophies of time

- The Andromeda Paradox
- Consequences of the Andromeda Paradox
- Other simultaneity relations ? (1)
- Other simultaneity relations ? (2)
- Accelerated observers and PE
- Accelerated observers and OS
- Presentism and possibilism in General Relativity
- Closed time-like curves
- Quantum heads-or-tails
- The positivistic and realist postulates
- Conclusion

Philosophies of time

1. Presentism: only the present exists

- (a) Time passes,
- (b) The future is open,
- (c) One may travel in space, not in time,
- (d) Ontological parsimony.

2. Possibilism (growing universe): the present and the past exist

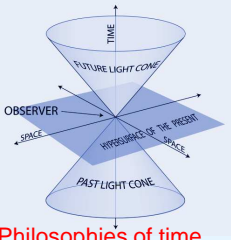

● Philosophies of time

- The Andromeda Paradox
- Consequences of the Andromeda Paradox
- Other simultaneity relations ? (1)
- Other simultaneity relations ? (2)
- Accelerated observers and PE
- Accelerated observers and OS
- Presentism and possibilism in General Relativity
- Closed time-like curves
- Quantum heads-or-tails
- The positivistic and realist postulates
- Conclusion

Philosophies of time

1. Presentism: only the present exists
 - (a) Time passes,
 - (b) The future is open,
 - (c) One may travel in space, not in time,
 - (d) Ontological parsimony.

2. Possibilism (growing universe): the present and the past exist
 - (a) Reality grows,
 - (b) The future is open.

3. Eternalism (block-universe): the past, the present, and the future exist

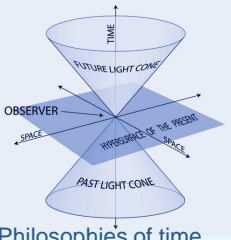

- Philosophies of time
- **The Andromeda Paradox**
- Consequences of the Andromeda Paradox
- Other simultaneity relations ? (1)
- Other simultaneity relations ? (2)
- Accelerated observers and PE
- Accelerated observers and OS
- Presentism and possibilism in General Relativity
- Closed time-like curves
- Quantum heads-or-tails
- The positivistic and realist postulates
- Conclusion

The Andromeda Paradox

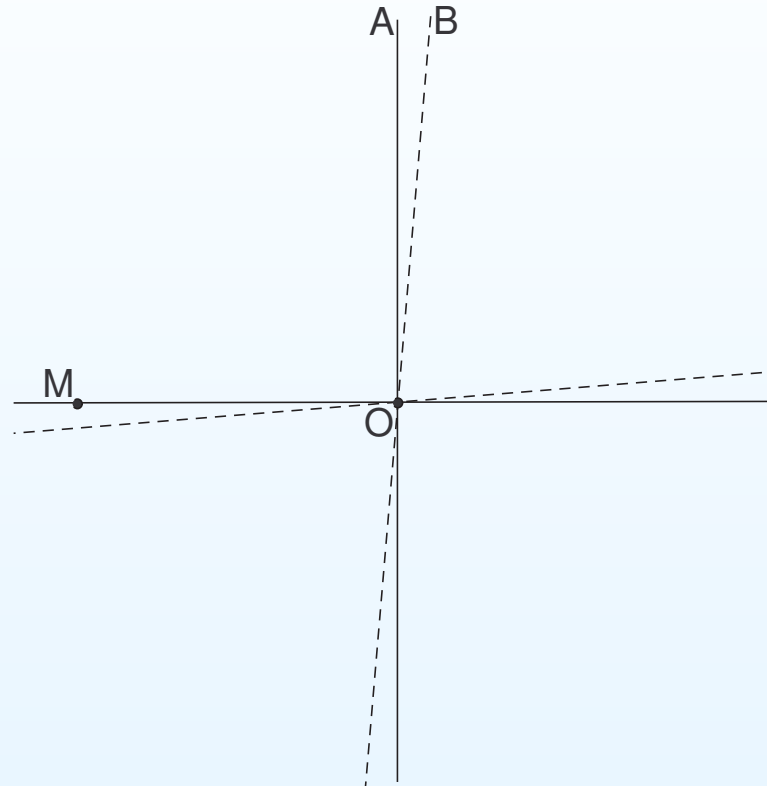

On Earth, A and B meet at O , relative speed = 4 km/h.

Event M : Andromedians launch a float of spaceships to invade Earth.

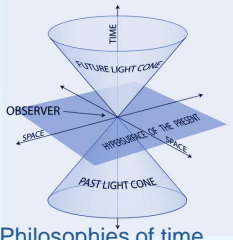

- Philosophies of time
- The Andromeda Paradox
- **Consequences of the Andromeda Paradox**
- Other simultaneity relations ? (1)
- Other simultaneity relations ? (2)
- Accelerated observers and PE
- Accelerated observers and OS
- Presentism and possibilism in General Relativity
- Closed time-like curves
- Quantum heads-or-tails
- The positivistic and realist postulates
- Conclusion

Consequences of the Andromeda Paradox

Presentism implies that reality depends on simultaneity.
SR implies that simultaneity depends on the observer.

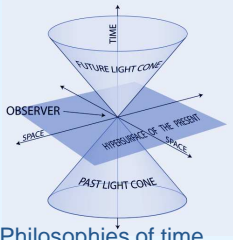

- Philosophies of time
- The Andromeda Paradox
- **Consequences of the Andromeda Paradox**
- Other simultaneity relations ? (1)
- Other simultaneity relations ? (2)
- Accelerated observers and PE
- Accelerated observers and OS
- Presentism and possibilism in General Relativity
- Closed time-like curves
- Quantum heads-or-tails
- The positivistic and realist postulates
- Conclusion

Consequences of the Andromeda Paradox

Presentism implies that reality depends on simultaneity.

SR implies that simultaneity depends on the observer.

Thus one cannot hold the following together:

1. there exists an objective, observer-independent reality,
2. a philosophy of time must be compatible with SR,
3. presentism/possibilism.

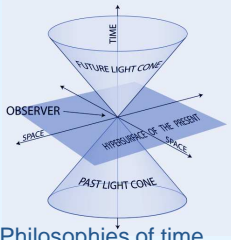

- Philosophies of time
- The Andromeda Paradox
- **Consequences of the Andromeda Paradox**
- Other simultaneity relations ? (1)
- Other simultaneity relations ? (2)
- Accelerated observers and PE
- Accelerated observers and OS
- Presentism and possibilism in General Relativity
- Closed time-like curves
- Quantum heads-or-tails
- The positivistic and realist postulates
- Conclusion

Consequences of the Andromeda Paradox

Presentism implies that reality depends on simultaneity.

SR implies that simultaneity depends on the observer.

Thus one cannot hold the following together:

1. there exists an objective, observer-independent reality,
2. a philosophy of time must be compatible with SR,
3. presentism/possibilism.

$$MR_{\mathcal{B}}O \Leftrightarrow "M \text{ is real for } \mathcal{B} \text{ when } \mathcal{B} \text{ is at } O"$$

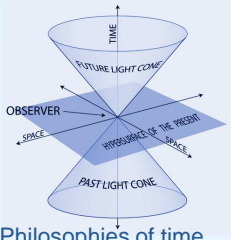

- Philosophies of time
- The Andromeda Paradox
- **Consequences of the Andromeda Paradox**
- Other simultaneity relations ? (1)
- Other simultaneity relations ? (2)
- Accelerated observers and PE
- Accelerated observers and OS
- Presentism and possibilism in General Relativity
- Closed time-like curves
- Quantum heads-or-tails
- The positivistic and realist postulates
- Conclusion

Consequences of the Andromeda Paradox

Presentism implies that reality depends on simultaneity.

SR implies that simultaneity depends on the observer.

Thus one cannot hold the following together:

1. there exists an objective, observer-independent reality,
2. a philosophy of time must be compatible with SR,
3. presentism/possibilism.

$$MR_{\mathcal{B}}O \Leftrightarrow "M \text{ is real for } \mathcal{B} \text{ when } \mathcal{B} \text{ is at } O"$$

$$1. NR_{\mathcal{A}}M \not\equiv MR_{\mathcal{B}}N$$

$$2. MR_{\mathcal{A}}O \not\equiv MR_{\mathcal{B}}O$$

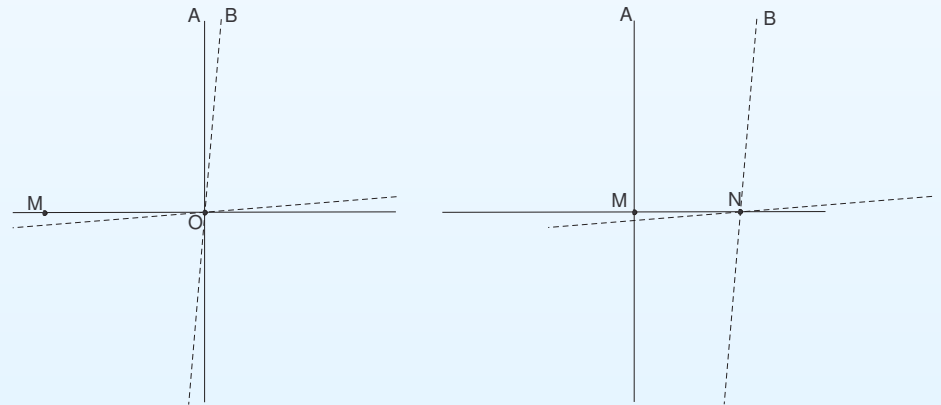

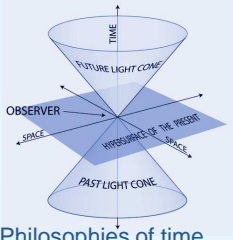

- Philosophies of time
- The Andromeda Paradox
- **Consequences of the Andromeda Paradox**
- Other simultaneity relations ? (1)
- Other simultaneity relations ? (2)
- Accelerated observers and PE
- Accelerated observers and OS
- Presentism and possibilism in General Relativity
- Closed time-like curves
- Quantum heads-or-tails
- The positivistic and realist postulates
- Conclusion

Consequences of the Andromeda Paradox

Presentism implies that reality depends on simultaneity.

SR implies that simultaneity depends on the observer.

Thus one cannot hold the following together:

1. there exists an objective, observer-independent reality,
2. a philosophy of time must be compatible with SR,
3. presentism/possibilism.

$$MR_{\mathcal{B}}O \Leftrightarrow "M \text{ is real for } \mathcal{B} \text{ when } \mathcal{B} \text{ is at } O"$$

$$1. NR_{\mathcal{A}}M \not\equiv MR_{\mathcal{B}}N$$

$$2. MR_{\mathcal{A}}O \not\equiv MR_{\mathcal{B}}O$$

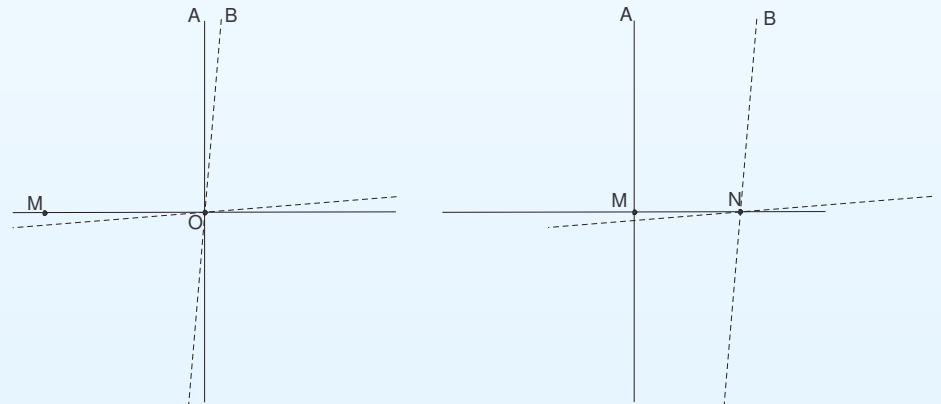

- Presentism turns away from common sense.
- The reality of \mathcal{O} depends on \mathcal{O} 's movement: weird !

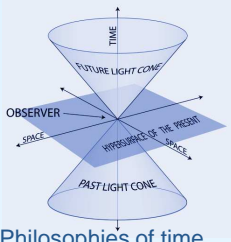

- Philosophies of time
- The Andromeda Paradox
- Consequences of the Andromeda Paradox
- **Other simultaneity relations ? (1)**
- Other simultaneity relations ? (2)
- Accelerated observers and PE
- Accelerated observers and OS
- Presentism and possibilism in General Relativity
- Closed time-like curves
- Quantum heads-or-tails
- The positivistic and realist postulates
- Conclusion

Other simultaneity relations ? (1)

Poincaré-Einstein convention (PE):

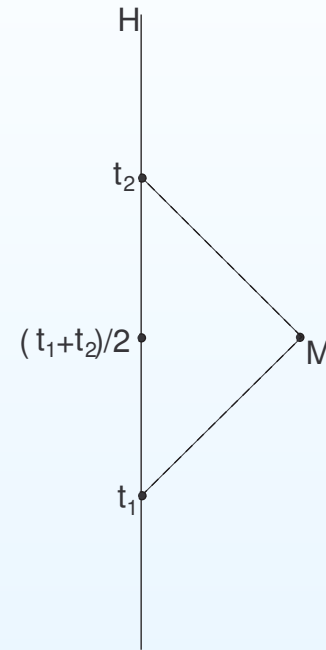

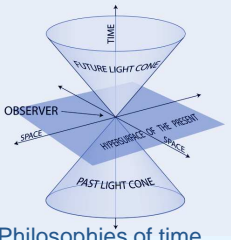

- Philosophies of time
- The Andromeda Paradox
- Consequences of the Andromeda Paradox
- **Other simultaneity relations ? (1)**
- Other simultaneity relations ? (2)
- Accelerated observers and PE
- Accelerated observers and OS
- Presentism and possibilism in General Relativity
- Closed time-like curves
- Quantum heads-or-tails
- The positivistic and realist postulates
- Conclusion

Other simultaneity relations ? (1)

Poincaré-Einstein convention (PE):

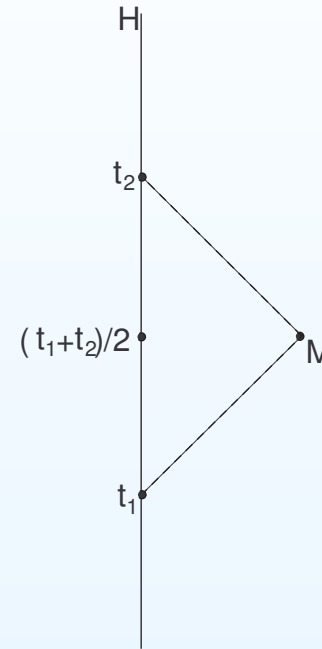

Theorem [Malament, 1977] *Let \mathcal{H} = be (the world-line of) an inertial observer. PE relation wrt \mathcal{H} is the only one which is:*

1. *a non-trivial equivalence relation,*
2. *invariant under causal automorphisms which stabilize \mathcal{H} .*

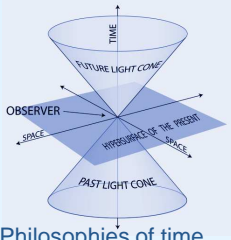

- Philosophies of time
- The Andromeda Paradox
- Consequences of the Andromeda Paradox
- Other simultaneity relations ? (1)
- **Other simultaneity relations ? (2)**
- Accelerated observers and PE
- Accelerated observers and OS
- Presentism and possibilism in General Relativity
- Closed time-like curves
- Quantum heads-or-tails
- The positivistic and realist postulates
- Conclusion

Other simultaneity relations ? (2)

Invariance under causal automorphisms is too strong → allow only those which preserve a spatial and a temporal orientation.

Theorem [Sarkar & Stachel, 1999]

1. *PE is the only relation which satisfies the above requirements and only depends on the direction of \mathcal{H} .*
2. *The relations defined by the past (resp. future) light cones are the only ones which satisfy the above requirements and only depend on the position of \mathcal{H} .*

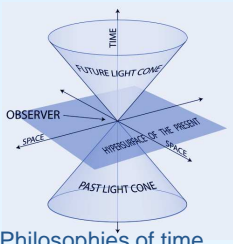

- Philosophies of time
- The Andromeda Paradox
- Consequences of the Andromeda Paradox
- Other simultaneity relations ? (1)
- **Other simultaneity relations ? (2)**
- Accelerated observers and PE
- Accelerated observers and OS
- Presentism and possibilism in General Relativity
- Closed time-like curves
- Quantum heads-or-tails
- The positivistic and realist postulates
- Conclusion

Other simultaneity relations ? (2)

Invariance under causal automorphisms is too strong → allow only those which preserve a spatial and a temporal orientation.

Theorem [Sarkar & Stachel, 1999]

1. *PE is the only relation which satisfies the above requirements and only depends on the direction of \mathcal{H} .*
2. *The relations defined by the past (resp. future) light cones are the only ones which satisfy the above requirements and only depend on the position of \mathcal{H} .*

→ 2 possible definitions of the present: PE and OS (observed simultaneity).

→ 2 possible versions of (relativized) presentism/possibilism.

A clear-cut definition of reality for OS presentism: “what is real is what I see”.

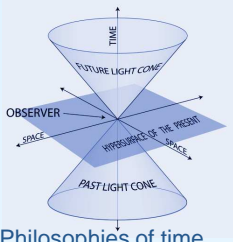

- Philosophies of time
- The Andromeda Paradox
- Consequences of the Andromeda Paradox
- Other simultaneity relations ? (1)
- Other simultaneity relations ? (2)
- **Accelerated observers and PE**
- Accelerated observers and OS
- Presentism and possibilism in General Relativity
- Closed time-like curves
- Quantum heads-or-tails
- The positivistic and realist postulates
- Conclusion

Accelerated observers and PE

An observer which is inertial, then accelerated, then inertial.

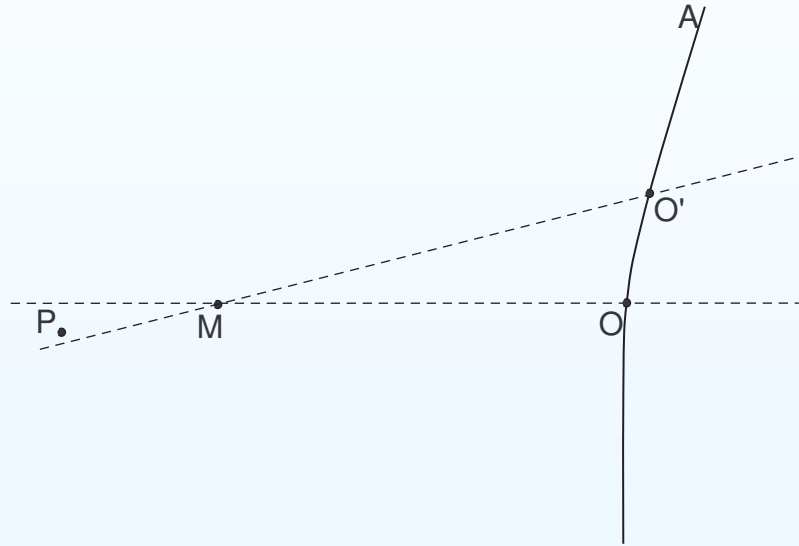

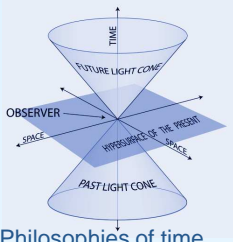

- Philosophies of time
- The Andromeda Paradox
- Consequences of the Andromeda Paradox
- Other simultaneity relations ? (1)
- Other simultaneity relations ? (2)
- **Accelerated observers and PE**
- Accelerated observers and OS
- Presentism and possibilism in General Relativity
- Closed time-like curves
- Quantum heads-or-tails
- The positivistic and realist postulates
- Conclusion

Accelerated observers and PE

An observer which is inertial, then accelerated, then inertial.

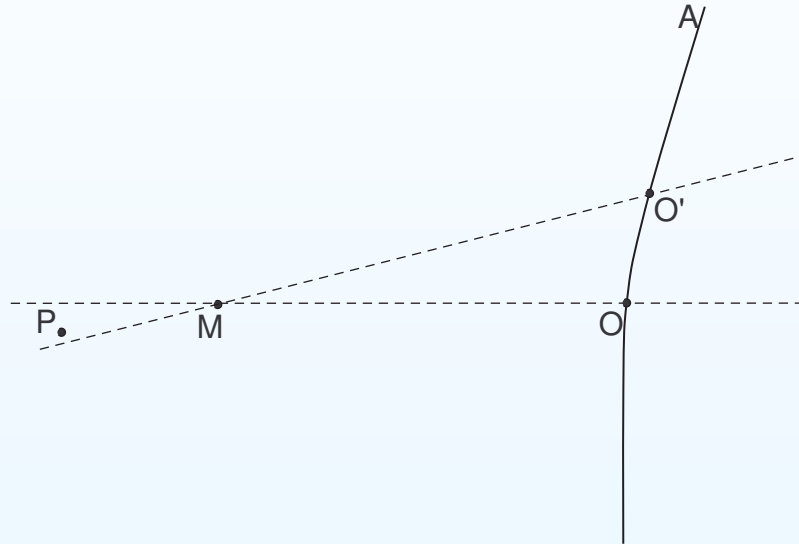

M is present for \mathcal{A} both at O and at O' .

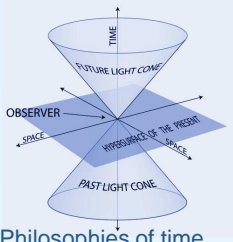

- Philosophies of time
- The Andromeda Paradox
- Consequences of the Andromeda Paradox
- Other simultaneity relations ? (1)
- Other simultaneity relations ? (2)
- Accelerated observers and PE
- Accelerated observers and OS
- Presentism and possibilism in General Relativity
- Closed time-like curves
- Quantum heads-or-tails
- The positivistic and realist postulates
- Conclusion

Accelerated observers and PE

An observer which is inertial, then accelerated, then inertial.

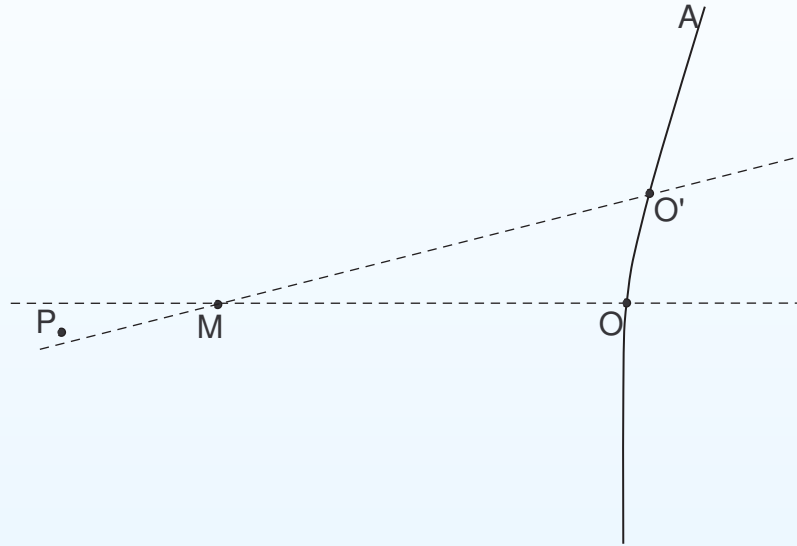

M is present for \mathcal{A} both at O and at O' .

P is in the past for \mathcal{A} at some moment, but later it's in the future !

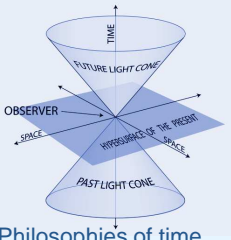

- Philosophies of time
- The Andromeda Paradox
- Consequences of the Andromeda Paradox
- Other simultaneity relations ? (1)
- Other simultaneity relations ? (2)
- Accelerated observers and PE
- Accelerated observers and OS
- Presentism and possibilism in General Relativity
- Closed time-like curves
- Quantum heads-or-tails
- The positivistic and realist postulates
- Conclusion

Accelerated observers and PE

An observer which is inertial, then accelerated, then inertial.

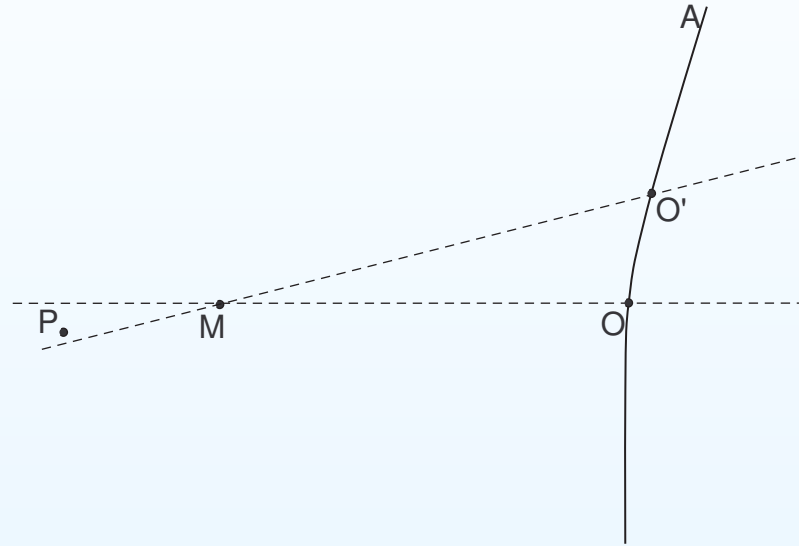

M is present for \mathcal{A} both at O and at O' .

P is in the past for \mathcal{A} at some moment, but later it's in the future !

→ PE version of the present is only local.

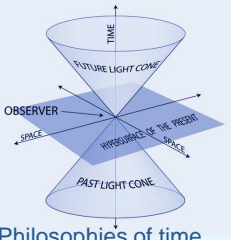

- Philosophies of time
- The Andromeda Paradox
- Consequences of the Andromeda Paradox
- Other simultaneity relations ? (1)
- Other simultaneity relations ? (2)
- Accelerated observers and PE
- Accelerated observers and OS
- Presentism and possibilism in General Relativity
- Closed time-like curves
- Quantum heads-or-tails
- The positivistic and realist postulates
- Conclusion

Accelerated observers and OS

In SR, past cones do not intersect.

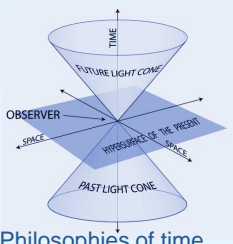

- Philosophies of time
- The Andromeda Paradox
- Consequences of the Andromeda Paradox
- Other simultaneity relations ? (1)
- Other simultaneity relations ? (2)
- Accelerated observers and PE
- Accelerated observers and OS
- Presentism and possibilism in General Relativity
- Closed time-like curves
- Quantum heads-or-tails
- The positivistic and realist postulates
- Conclusion

Accelerated observers and OS

In SR, past cones do not intersect.
 A uniformly accelerated observer:

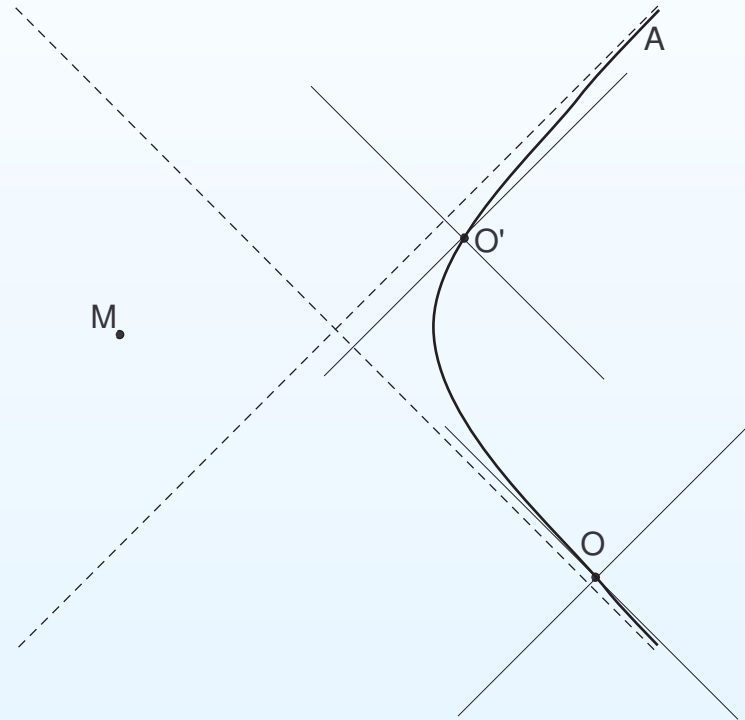

Some events are never in the present of \mathcal{A} !

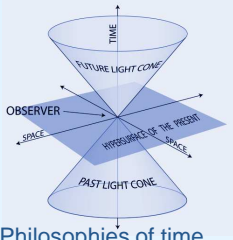

- Philosophies of time
- The Andromeda Paradox
- Consequences of the Andromeda Paradox
- Other simultaneity relations ? (1)
- Other simultaneity relations ? (2)
- Accelerated observers and PE
- Accelerated observers and OS
- Presentism and possibilism in General Relativity
- Closed time-like curves
- Quantum heads-or-tails
- The positivistic and realist postulates
- Conclusion

Accelerated observers and OS

In SR, past cones do not intersect.
A uniformly accelerated observer:

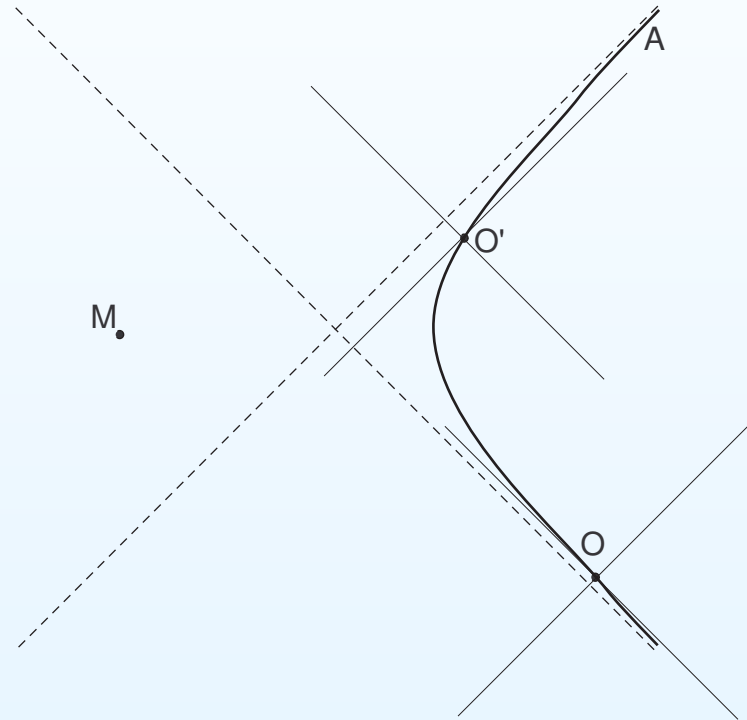

Some events are never in the present of \mathcal{A} !

→ OS version of the present is also local (but in a more natural way).

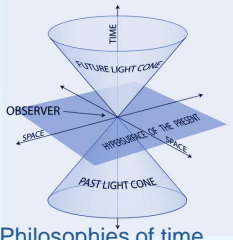

- Philosophies of time
- The Andromeda Paradox
- Consequences of the Andromeda Paradox
- Other simultaneity relations ? (1)
- Other simultaneity relations ? (2)
- Accelerated observers and PE
- Accelerated observers and OS
- Presentism and possibilism in General Relativity
- Closed time-like curves
- Quantum heads-or-tails
- The positivistic and realist postulates
- Conclusion

Presentism and possibilism in General Relativity

Two new features:

- the metric is not a background structure anymore + it has non-vanishing curvature
- the global topology might be non-trivial.

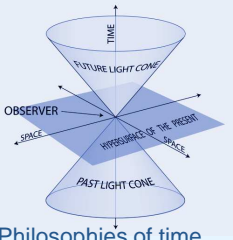

- Philosophies of time
- The Andromeda Paradox
- Consequences of the Andromeda Paradox
- Other simultaneity relations ? (1)
- Other simultaneity relations ? (2)
- Accelerated observers and PE
- Accelerated observers and OS
- Presentism and possibilism in General Relativity
- Closed time-like curves
- Quantum heads-or-tails
- The positivistic and realist postulates
- Conclusion

Presentism and possibilism in General Relativity

Two new features:

- the metric is not a background structure anymore + it has non-vanishing curvature
- the global topology might be non-trivial.

PE becomes purely conventional.

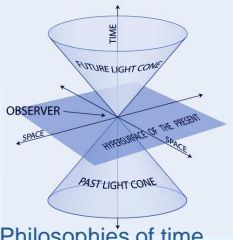

- Philosophies of time
- The Andromeda Paradox
- Consequences of the Andromeda Paradox
- Other simultaneity relations ? (1)
- Other simultaneity relations ? (2)
- Accelerated observers and PE
- Accelerated observers and OS
- Presentism and possibilism in General Relativity
- Closed time-like curves
- Quantum heads-or-tails
- The positivistic and realist postulates
- Conclusion

Presentism and possibilism in General Relativity

Two new features:

- the metric is not a background structure anymore + it has non-vanishing curvature
- the global topology might be non-trivial.

PE becomes purely conventional.

OS still has a physical meaning, but:

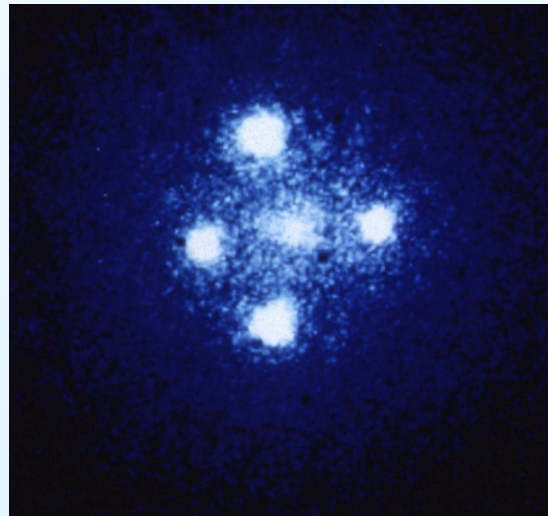

the past light cones generally intersect.

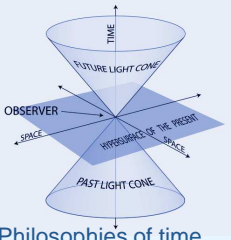

Closed time-like curves

- Philosophies of time
- The Andromeda Paradox
- Consequences of the Andromeda Paradox
- Other simultaneity relations ? (1)
- Other simultaneity relations ? (2)
- Accelerated observers and PE
- Accelerated observers and OS
- Presentism and possibilism in General Relativity
- **Closed time-like curves**
- Quantum heads-or-tails
- The positivistic and realist postulates
- Conclusion

So far, GR \implies

1. only OS convention is consistent,
2. an event can be both past and present: OS possibilism still works, but not presentism,
3. reality is local for *every* observer (absolute event horizons).

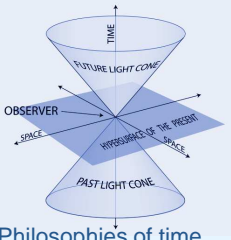

- Philosophies of time
- The Andromeda Paradox
- Consequences of the Andromeda Paradox
- Other simultaneity relations ? (1)
- Other simultaneity relations ? (2)
- Accelerated observers and PE
- Accelerated observers and OS
- Presentism and possibilism in General Relativity
- **Closed time-like curves**
- Quantum heads-or-tails
- The positivistic and realist postulates
- Conclusion

Closed time-like curves

So far, GR \implies

1. only OS convention is consistent,
2. an event can be both past and present: OS possibilism still works, but not presentism,
3. reality is local for *every* observer (absolute event horizons).

But if CTC's exist, even OS possibilism becomes inconsistent !

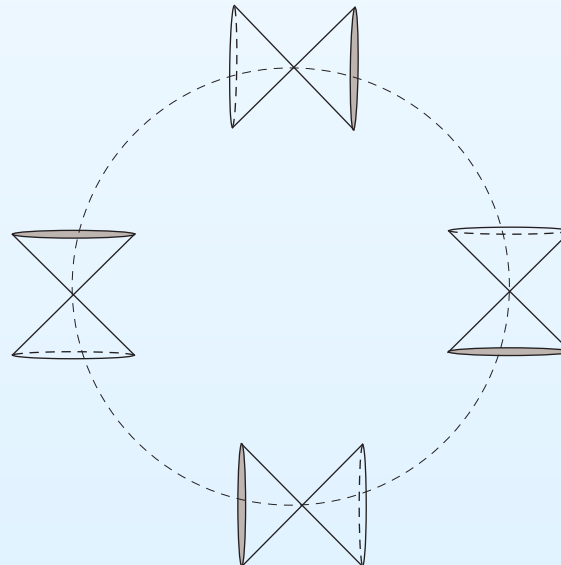

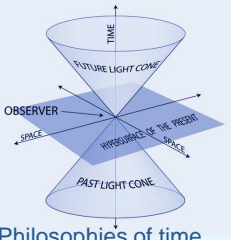

- Philosophies of time
- The Andromeda Paradox
- Consequences of the Andromeda Paradox
- Other simultaneity relations ? (1)
- Other simultaneity relations ? (2)
- Accelerated observers and PE
- Accelerated observers and OS
- Presentism and possibilism in General Relativity
- Closed time-like curves
- **Quantum heads-or-tails**
- The positivistic and realist postulates
- Conclusion

Quantum heads-or-tails

$S = \text{spin-1/2}$ particle prepared in pure state $|+, z\rangle$

Sequence of measures along (Oz) , (Ox) , (Oz) etc... at time interval

$\Delta\tau > 0$.

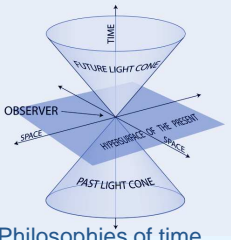

- Philosophies of time
- The Andromeda Paradox
- Consequences of the Andromeda Paradox
- Other simultaneity relations ? (1)
- Other simultaneity relations ? (2)
- Accelerated observers and PE
- Accelerated observers and OS
- Presentism and possibilism in General Relativity
- Closed time-like curves
- **Quantum heads-or-tails**
- The positivistic and realist postulates
- Conclusion

Quantum heads-or-tails

$S = \text{spin-1/2}$ particle prepared in pure state $|+, z\rangle$

Sequence of measures along (Oz) , (Ox) , (Oz) etc... at time interval

$\Delta\tau > 0$.

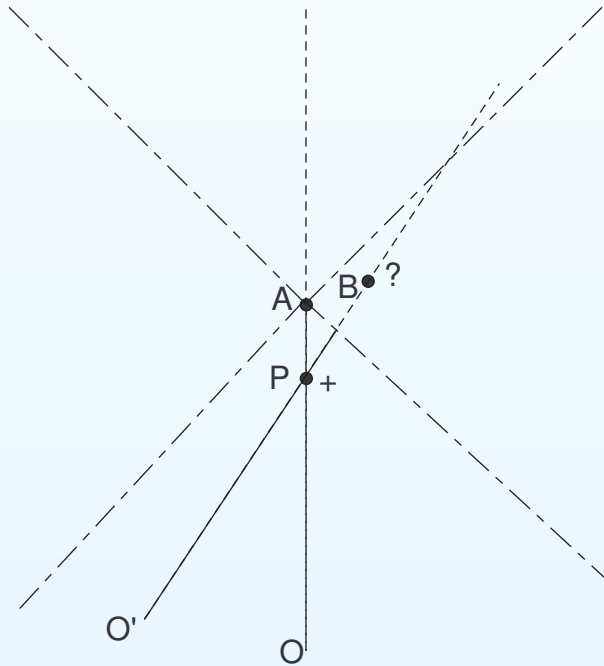

- A fixed, P varies in the past of A on \mathcal{O} .
- B can be anywhere in the elsewhere of future of A .

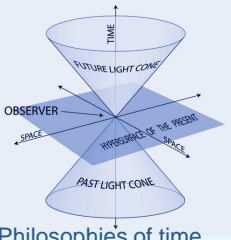

- Philosophies of time
- The Andromeda Paradox
- Consequences of the Andromeda Paradox
- Other simultaneity relations ? (1)
- Other simultaneity relations ? (2)
- Accelerated observers and PE
- Accelerated observers and OS
- Presentism and possibilism in General Relativity
- Closed time-like curves
- Quantum heads-or-tails
- The positivistic and realist postulates
- Conclusion

The positivistic and realist postulates

Postulate P *what cannot be determined for an observer, even in principle, is not real for this observer.*

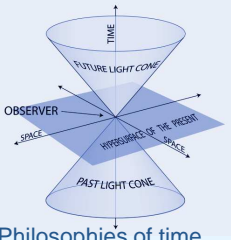

- Philosophies of time
- The Andromeda Paradox
- Consequences of the Andromeda Paradox
- Other simultaneity relations ? (1)
- Other simultaneity relations ? (2)
- Accelerated observers and PE
- Accelerated observers and OS
- Presentism and possibilism in General Relativity
- Closed time-like curves
- Quantum heads-or-tails
- **The positivistic and realist postulates**
- Conclusion

The positivistic and realist postulates

Postulate P *what cannot be determined for an observer, even in principle, is not real for this observer.*

- at the root of presentism/possibilism !

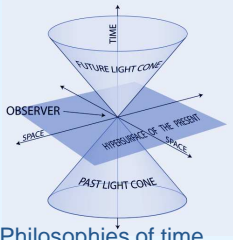

- Philosophies of time
- The Andromeda Paradox
- Consequences of the Andromeda Paradox
- Other simultaneity relations ? (1)
- Other simultaneity relations ? (2)
- Accelerated observers and PE
- Accelerated observers and OS
- Presentism and possibilism in General Relativity
- Closed time-like curves
- Quantum heads-or-tails
- The positivistic and realist postulates
- Conclusion

The positivistic and realist postulates

Postulate P *what cannot be determined for an observer, even in principle, is not real for this observer.*

- at the root of presentism/possibilism !
- Postulate P + QM rule out PE presentism/possibilism and eternalism.

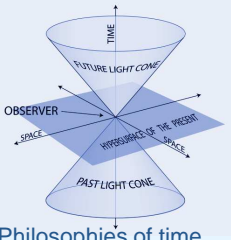

- Philosophies of time
- The Andromeda Paradox
- Consequences of the Andromeda Paradox
- Other simultaneity relations ? (1)
- Other simultaneity relations ? (2)
- Accelerated observers and PE
- Accelerated observers and OS
- Presentism and possibilism in General Relativity
- Closed time-like curves
- Quantum heads-or-tails
- **The positivistic and realist postulates**
- Conclusion

The positivistic and realist postulates

Postulate P *what cannot be determined for an observer, even in principle, is not real for this observer.*

- at the root of presentism/possibilism !
- Postulate P + QM rule out PE presentism/possibilism and eternalism.
- OS presentism/possibilism survive.

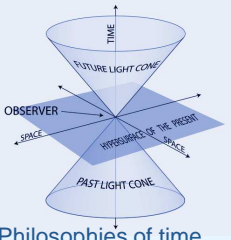

- Philosophies of time
- The Andromeda Paradox
- Consequences of the Andromeda Paradox
- Other simultaneity relations ? (1)
- Other simultaneity relations ? (2)
- Accelerated observers and PE
- Accelerated observers and OS
- Presentism and possibilism in General Relativity
- Closed time-like curves
- Quantum heads-or-tails
- **The positivistic and realist postulates**
- Conclusion

The positivistic and realist postulates

Postulate P *what cannot be determined for an observer, even in principle, is not real for this observer.*

- at the root of presentism/possibilism !
- Postulate P + QM rule out PE presentism/possibilism and eternalism.
- OS presentism/possibilism survive.

Eternalism can survive QM only by a dismissal of Postulate P.

Postulate R *Reality is independent from the observer/observations.*

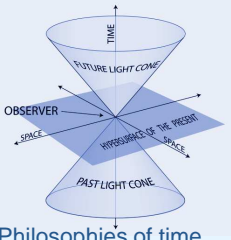

- Philosophies of time
- The Andromeda Paradox
- Consequences of the Andromeda Paradox
- Other simultaneity relations ? (1)
- Other simultaneity relations ? (2)
- Accelerated observers and PE
- Accelerated observers and OS
- Presentism and possibilism in General Relativity
- Closed time-like curves
- Quantum heads-or-tails
- **The positivistic and realist postulates**
- Conclusion

The positivistic and realist postulates

Postulate P *what cannot be determined for an observer, even in principle, is not real for this observer.*

- at the root of presentism/possibilism !
- Postulate P + QM rule out PE presentism/possibilism and eternalism.
- OS presentism/possibilism survive.

Eternalism can survive QM only by a dismissal of Postulate P.

Postulate R *Reality is independent from the observer/observations.*

- at the root of eternalism,

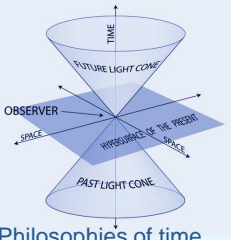

- Philosophies of time
- The Andromeda Paradox
- Consequences of the Andromeda Paradox
- Other simultaneity relations ? (1)
- Other simultaneity relations ? (2)
- Accelerated observers and PE
- Accelerated observers and OS
- Presentism and possibilism in General Relativity
- Closed time-like curves
- Quantum heads-or-tails
- **The positivistic and realist postulates**
- Conclusion

The positivistic and realist postulates

Postulate P *what cannot be determined for an observer, even in principle, is not real for this observer.*

- at the root of presentism/possibilism !
- Postulate P + QM rule out PE presentism/possibilism and eternalism.
- OS presentism/possibilism survive.

Eternalism can survive QM only by a dismissal of Postulate P.

Postulate R *Reality is independent from the observer/observations.*

- at the root of eternalism,
- Postulate R + QM \Rightarrow MWI.

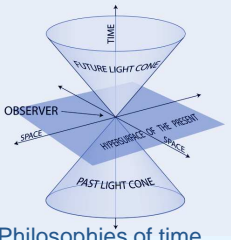

- Philosophies of time
- The Andromeda Paradox
- Consequences of the Andromeda Paradox
- Other simultaneity relations ? (1)
- Other simultaneity relations ? (2)
- Accelerated observers and PE
- Accelerated observers and OS
- Presentism and possibilism in General Relativity
- Closed time-like curves
- Quantum heads-or-tails
- **The positivistic and realist postulates**
- Conclusion

The positivistic and realist postulates

Postulate P *what cannot be determined for an observer, even in principle, is not real for this observer.*

- at the root of presentism/possibilism !
- Postulate P + QM rule out PE presentism/possibilism and eternalism.
- OS presentism/possibilism survive.

Eternalism can survive QM only by a dismissal of Postulate P.

Postulate R *Reality is independent from the observer/observations.*

- at the root of eternalism,
- Postulate R + QM \Rightarrow MWI.

Works as long as there is a mathematical structure encompassing all partial observations (Minkowski spacetime, GR spacetime, Everett multiverse)

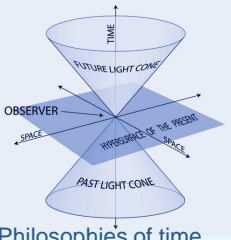

- Philosophies of time
- The Andromeda Paradox
- Consequences of the Andromeda Paradox
- Other simultaneity relations ? (1)
- Other simultaneity relations ? (2)
- Accelerated observers and PE
- Accelerated observers and OS
- Presentism and possibilism in General Relativity
- Closed time-like curves
- Quantum heads-or-tails
- The positivistic and realist postulates
- **Conclusion**

Conclusion

On the one hand: open future (pure randomness, free will ?), passage of time, ...

- Only my past cone exists,
- Only some portion of spacetime *ever* exists,
- Only my branch of the multiverse exists.

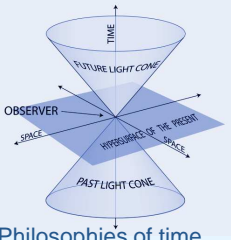

- Philosophies of time
- The Andromeda Paradox
- Consequences of the Andromeda Paradox
- Other simultaneity relations ? (1)
- Other simultaneity relations ? (2)
- Accelerated observers and PE
- Accelerated observers and OS
- Presentism and possibilism in General Relativity
- Closed time-like curves
- Quantum heads-or-tails
- The positivistic and realist postulates
- **Conclusion**

Conclusion

On the one hand: open future (pure randomness, free will ?), passage of time, ...

- Only my past cone exists,
- Only some portion of spacetime *ever* exists,
- Only my branch of the multiverse exists.

Presentism/possibilism + physics \implies “radical positivism”. Reality becomes narrower.

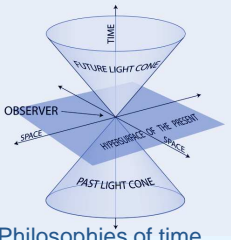

- Philosophies of time
- The Andromeda Paradox
- Consequences of the Andromeda Paradox
- Other simultaneity relations ? (1)
- Other simultaneity relations ? (2)
- Accelerated observers and PE
- Accelerated observers and OS
- Presentism and possibilism in General Relativity
- Closed time-like curves
- Quantum heads-or-tails
- The positivistic and realist postulates
- **Conclusion**

Conclusion

On the one hand: open future (pure randomness, free will ?), passage of time, ...

- Only my past cone exists,
- Only some portion of spacetime *ever* exists,
- Only my branch of the multiverse exists.

Presentism/possibilism + physics \implies “radical positivism”. Reality becomes narrower.

On the other hand: none of the above words has an objective meaning. What exists: all of spacetime, all branches of the multiverse,...

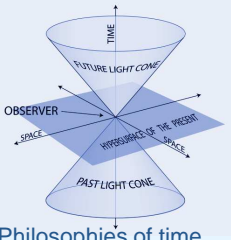

- Philosophies of time
- The Andromeda Paradox
- Consequences of the Andromeda Paradox
- Other simultaneity relations ? (1)
- Other simultaneity relations ? (2)
- Accelerated observers and PE
- Accelerated observers and OS
- Presentism and possibilism in General Relativity
- Closed time-like curves
- Quantum heads-or-tails
- The positivistic and realist postulates
- **Conclusion**

Conclusion

On the one hand: open future (pure randomness, free will ?), passage of time, ...

- Only my past cone exists,
- Only some portion of spacetime *ever* exists,
- Only my branch of the multiverse exists.

Presentism/possibilism + physics \implies “radical positivism”. Reality becomes narrower.

On the other hand: none of the above words has an objective meaning.

What exists: all of spacetime, all branches of the multiverse,...

These are timeless mathematical objects.

Eternalism + physics \implies mathematical ontology. Reality becomes bigger.